

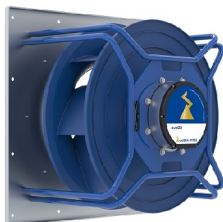

1



GR56C-ZID.GG.CR | 116182/A01 | Portfolio STD-WW | Cpro ECblue

### Standard design with ECblue motor and integrated electronics

#### Material of impeller:

- ZAmid - high performance composite material

#### Color Coating:

- Color coating in RAL5002 (Ultra marine-blue)

#### Mains voltage motor size B\_:

- 1~ 200...277 V; 50/60 Hz

#### Mains voltage motor size D\_:

- 1~ 200...277 V; 50/60 Hz
- 3~ 200...240 V; 50/60 Hz
- 3~ 380...480 V; 50/60 Hz

#### Mains voltage motor size G\_:

- 3~ 200...240 V; 50/60 Hz
- 3~ 380...480 V; 50/60 Hz

#### Thermal class:

- THCL155

#### Thermal protection:

- Protection with active temperature management

#### Protection:

- IP55

#### Coating:

- Motor painted in RAL5002 (Ultra marine-blue)

#### Controller (only motor size B\_):

- Activation via external speed setting 0-10 V / PWM, Communication interface on request
- Standard cable length: 60 cm

#### Controller (only motor size D\_, G\_):

# FANselect



- **BASIC:**

Activation via external speed setting 0-10 V / PWM Art. no. ER- and GR-module  
in basic version

- **PREMIUM:**

Integrated control functionality, Communication interface on request

**Cable glands:**

- Motor size D: 3 x M16 x 1.5
- Motor size G: 3 x M20 x 1.5

**Ambient temperature:**

- Minimum permissible ambient temperature: -20 °C\*
- Maximum permissible ambient temperature: 40 °C or see data sheet

**\*Continuous operation with occasional starts (S1) according to DIN EN 60034-1: 2011-02. Occasional starting between -35 ° C and -25 ° C is permissible. Permanent operation below -25 ° C only possible with special bearings for refrigeration applications on request.**



## fan data

16/12/2021

version FANselect V 1.01 (211209), AMCA V 1.03 September, 2021 / 1.21.12.09 | 53567 | (user ZAFS43567)



type	GR56C-ZID.GG.CR
article no.	116182/A01   Portfolio STD-WW

## technical data

motor	ECblue	
Efficiency class	IE5	
mains supply	-	3~ 400V 50Hz
ambient temperature, max. limit ( $t_r$ )	°C	45
efficiency grade $\eta_{statA}$	%	70,2
efficiency grade $N_{actual}$   $N_{target}$		<b>75,2</b>   62
ErP-conformity		2015   EC controller integrated
grille   influence		no

## fan data

<b>SFP-class</b>   SFP-value ( $P_{SFP}$ )	-   Ws/m <sup>3</sup>	<b>3</b>   1117
airflow volume ( $q_v$ )	ft <sup>3</sup> /min	6237.6
air velocity	ft/s	32.18
pressure, <b>stat.</b> ( $p_{sF}$ )   tot. ( $p_F$ )	in.wg.	<b>2.983</b>   3.202
electrical power input ( $P_{sys}$ )	W	3287
system eff., <b>stat.</b> ( $\eta_{sF,sys}$ )   tot. ( $\eta_{F,sys}$ )	%	<b>66.5</b>   71.4
fan speed ( <b>n</b> )   max. ( $n_{max}$ )	rpm	<b>1541</b>   1550
fan speed, set value (% $n_{max}$ )	%	99
frequency ( <b>f<sub>BP</sub></b> )   ( $f_{max}$ )	Hz	<b>50</b>   60
voltage ( $U_{DP}$ )	V	400
current ( $I_{DP}$ )	A	5.02
acoustics, suction side ( $L_{w(A),5}$ )   ( $L_{w,5}$ )	dB	<b>78</b>   83
acoustics, pressure side ( $L_{w(A),6}$ )   ( $L_{w,6}$ )	dB	<b>85</b>   89
dimensions (w x h x d)	in	28.74 x 28.74 x 19.53
product weight ( $m_{pr}$ )	lb	127.9
k-factor nozzle pres. (k)	-	308
differential pres. nozzle ( $p_{sF \text{ nozzle}}$ )	Pa	1184

PF:PF\_50; Ano:116182; STot:+-10 %





performance curve / acoustics

16/12/2021

version FANselect V 1.01 (211209), AMCA V 1.03 September, 2021 / 1.21.12.09 | 53567 | (user ZAFS43567)

**1 GR56C-ZID.GG.CR** measured in standard nozzle in installation type A according to ISO 5801  
 116182/A01 | Portfolio measurement density 0.072 [lbs/ft<sup>3</sup>]  
 STD-WWW

air performance  $p_{sF}$

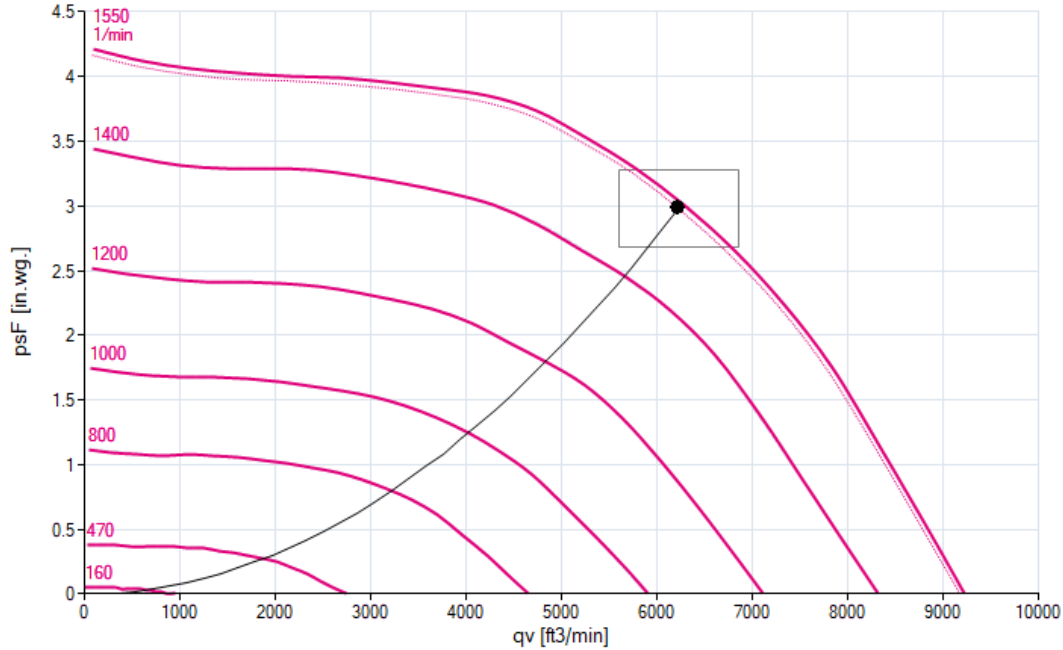

acoustics ( $L_{w(A),5}$ )

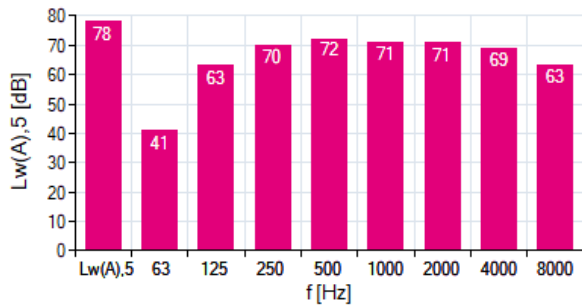

acoustics ( $L_{w(A),6}$ )

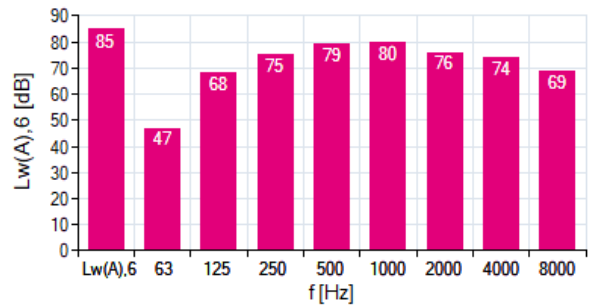

**1 GR56C-ZID.GG.CR**

f [Hz]	sum	63	125	250	500	1000	2000	4000	8000
$L_{w(A),5}$	78	41	63	70	72	71	71	69	63
$L_{w,5}$	83	66	76	79	76	71	69	68	64

f [Hz]	sum	63	125	250	500	1000	2000	4000	8000
$L_{w(A),6}$	85	47	68	75	79	80	76	74	69
$L_{w,6}$	89	73	82	85	83	80	75	73	70

# FANselect



efficiency grade / power input 16/12/2021  
version FANselect V 1.01 (211209), AMCA V 1.03 September, 2021 / 1.21.12.09 | 53567 | (user ZAFS43567)

① **GR56C-ZID.GG.CR** measured in standard nozzle in installation type A according to ISO 5801  
 116182/A01 | Portfolio measurement density 0.072 [lbs/ft<sup>3</sup>]  
 STD-WW

efficiency grade  $\eta_{F,sys}$

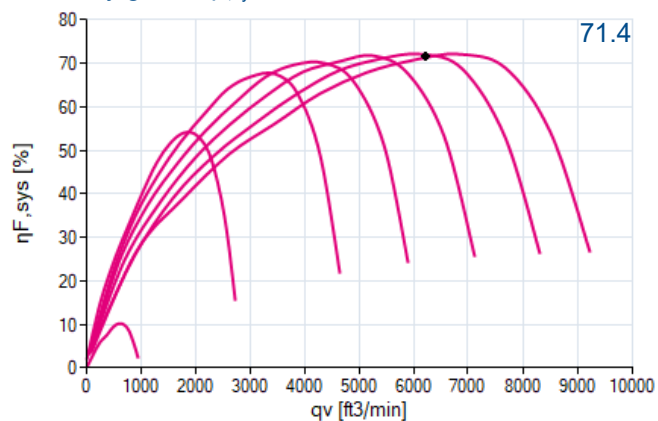

efficiency grade  $\eta_{sF,sys}$

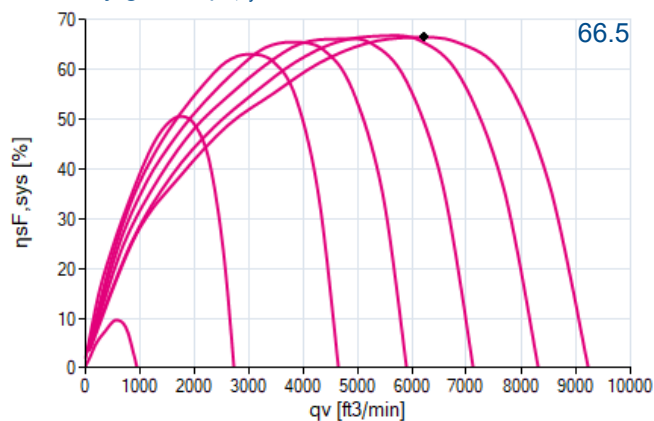

power input  $P_{sys}$

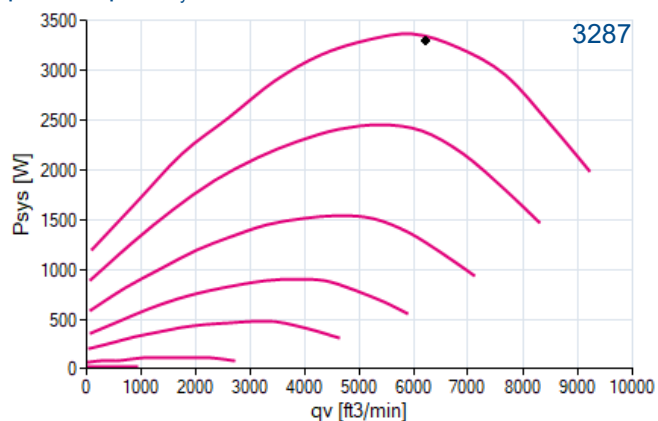



## nominal values

16/12/2021

version FANselect V 1.01 (211209), AMCA V 1.03 September, 2021 / 1.21.12.09 | 53567 | (user ZAFS43567)

1

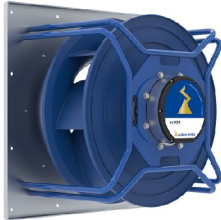

GR56C-ZID.GG.CR

116182/A01

3~ 380-480V 50Hz P1 3.40kW  
 5.40-4.20A 1550/MIN 45°C  
 3~ 380-480V 60Hz P1 3.40kW  
 5.40-4.20A 1550/MIN 45°C  
 IP55 THCL155

## drawing

16/12/2021

version FANselect V 1.01 (211209), AMCA V 1.03 September, 2021 / 1.21.12.09 | 53567 | (user ZAFS43567)

1

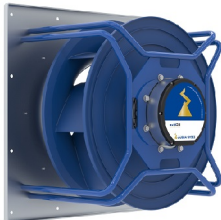

GR56C-ZID.GG.CR

116182/A01

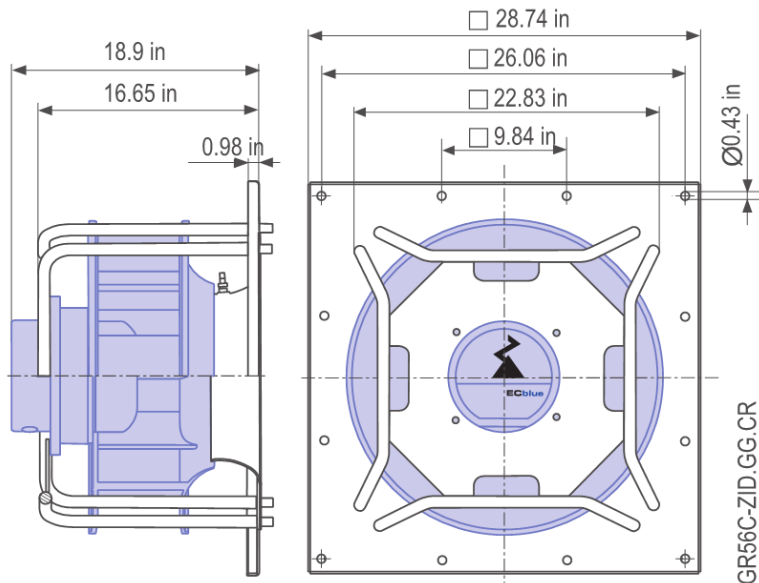

## wiring diagram

16/12/2021

version FANselect V 1.01 (211209), AMCA V 1.03 September, 2021 / 1.21.12.09 | 53567 | (user ZAFS43567)

1

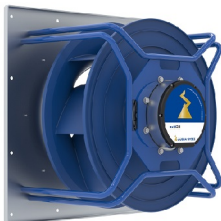

GR56C-ZID.GG.CR

116182/A01

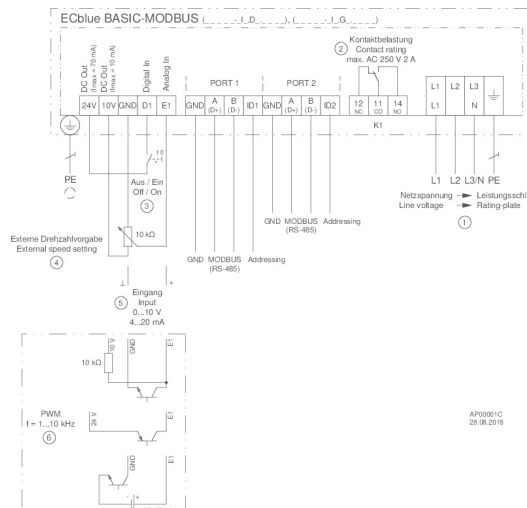



## system components

16/12/2021

version FANselect V 1.01 (211209), AMCA V 1.03 September, 2021 / 1.21.12.09 | 53567 | (user ZAFS43567)

1



type	GR56C-ZID.GG.CR
article no.	116182/A01